

# LOTO CRAFT

## 05 - Dream Flight 3D Decoupage

© 2012 TROY CHIN / DREARY WEARY COMICS

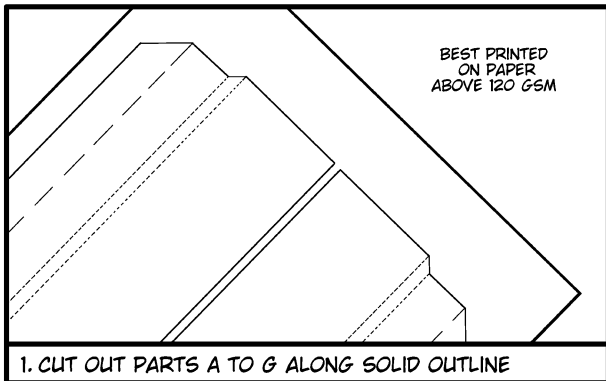
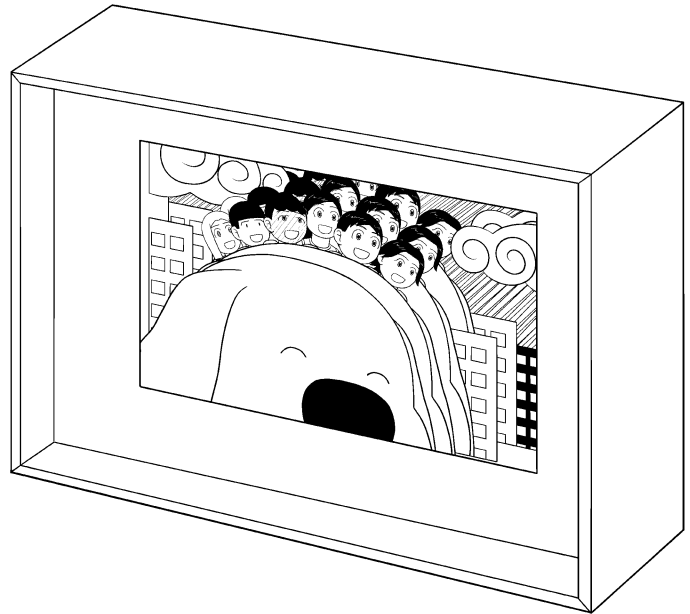

1. CUT OUT PARTS A TO G ALONG SOLID OUTLINE

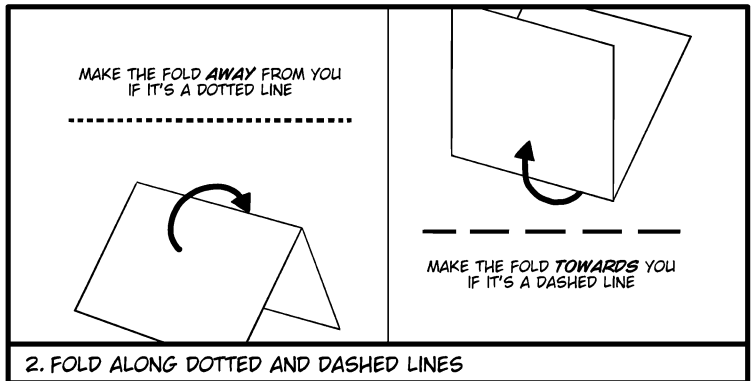

2. FOLD ALONG DOTTED AND DASHED LINES

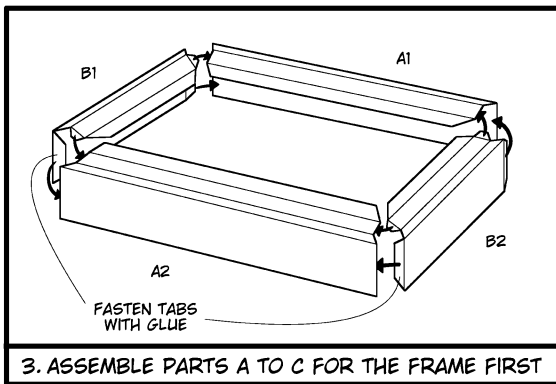

3. ASSEMBLE PARTS A TO C FOR THE FRAME FIRST

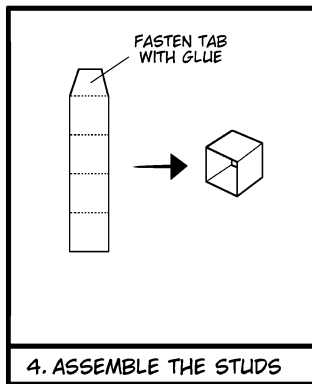

4. ASSEMBLE THE STUDS

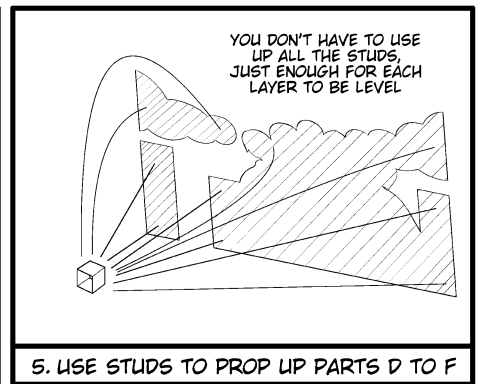

5. USE STUDS TO PROP UP PARTS D TO F

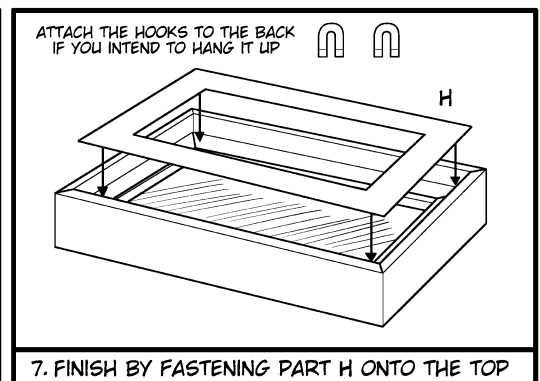
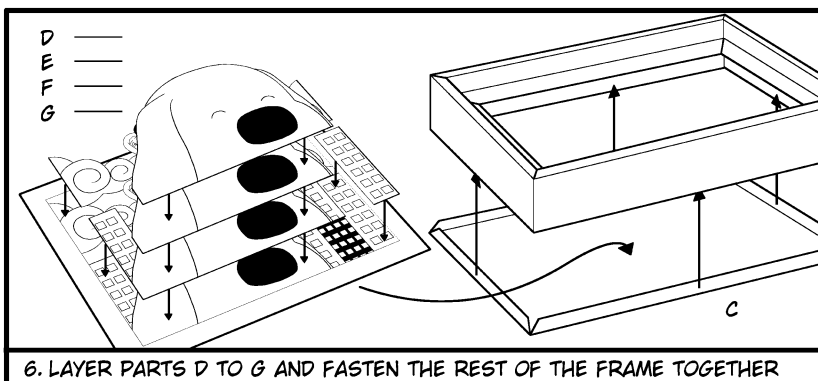

**A1**

**A2**

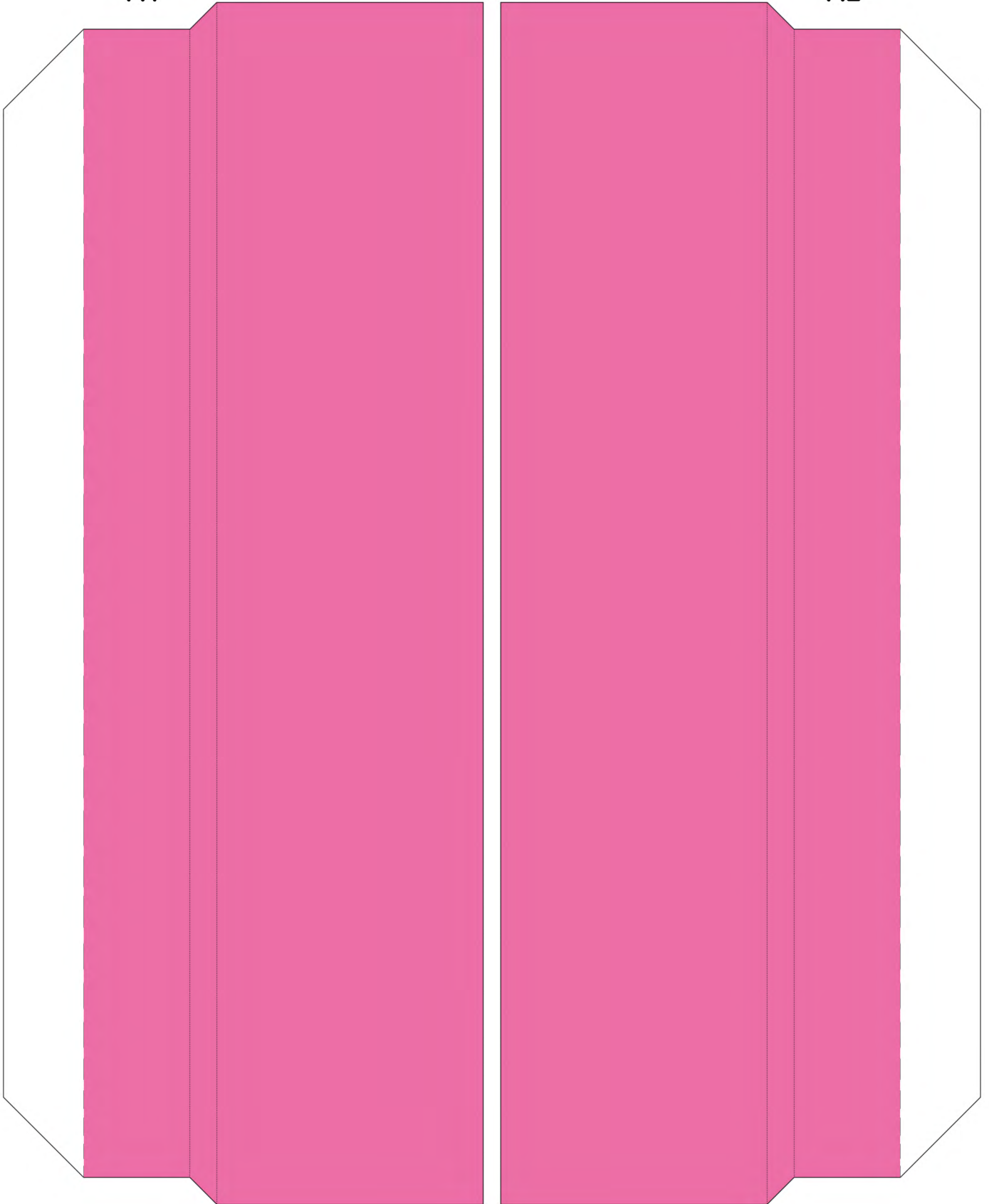

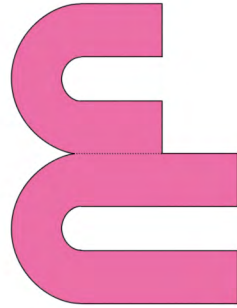
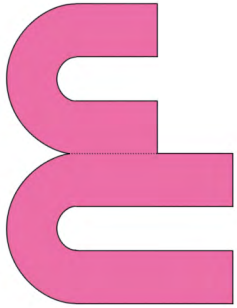
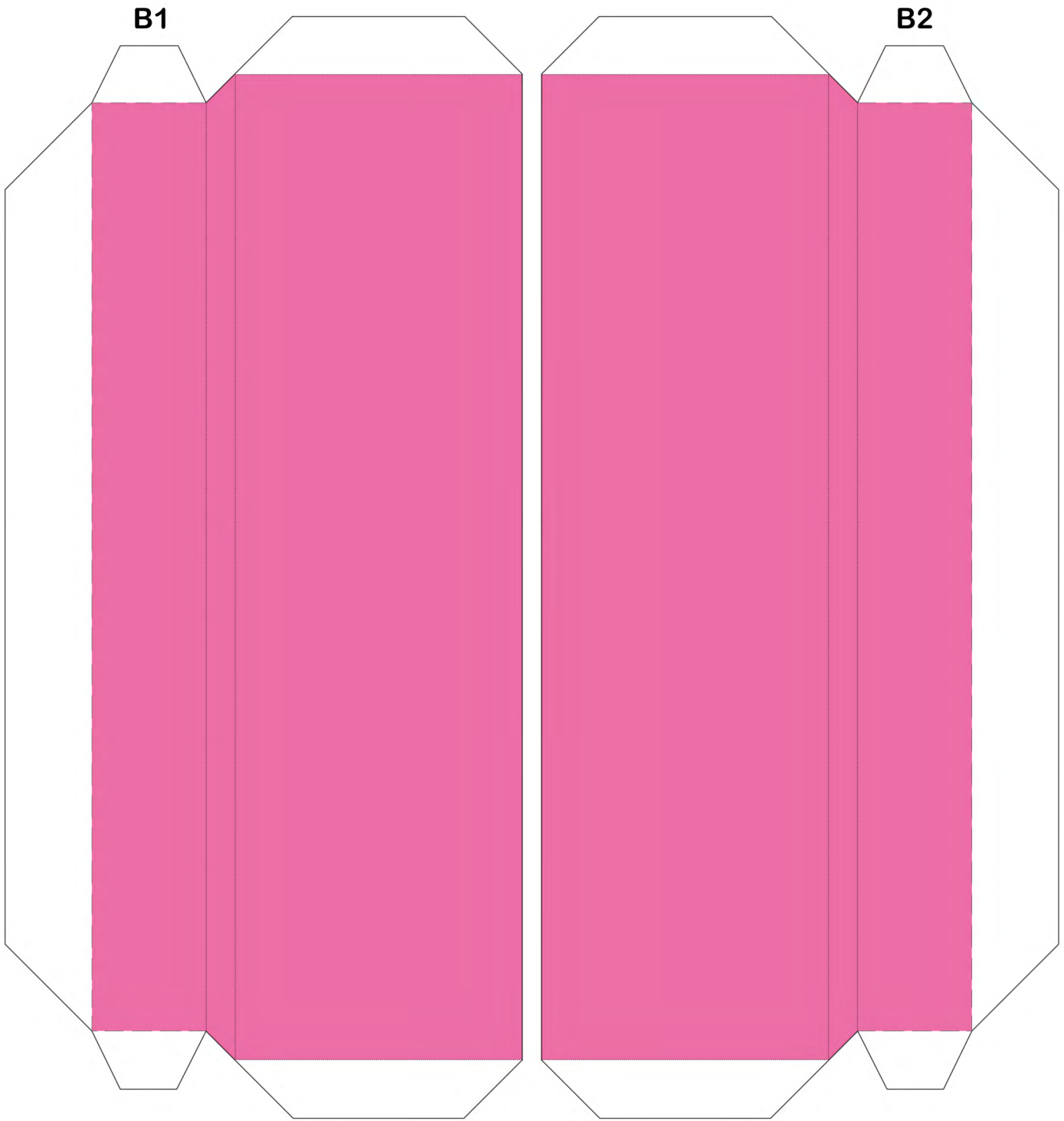

C

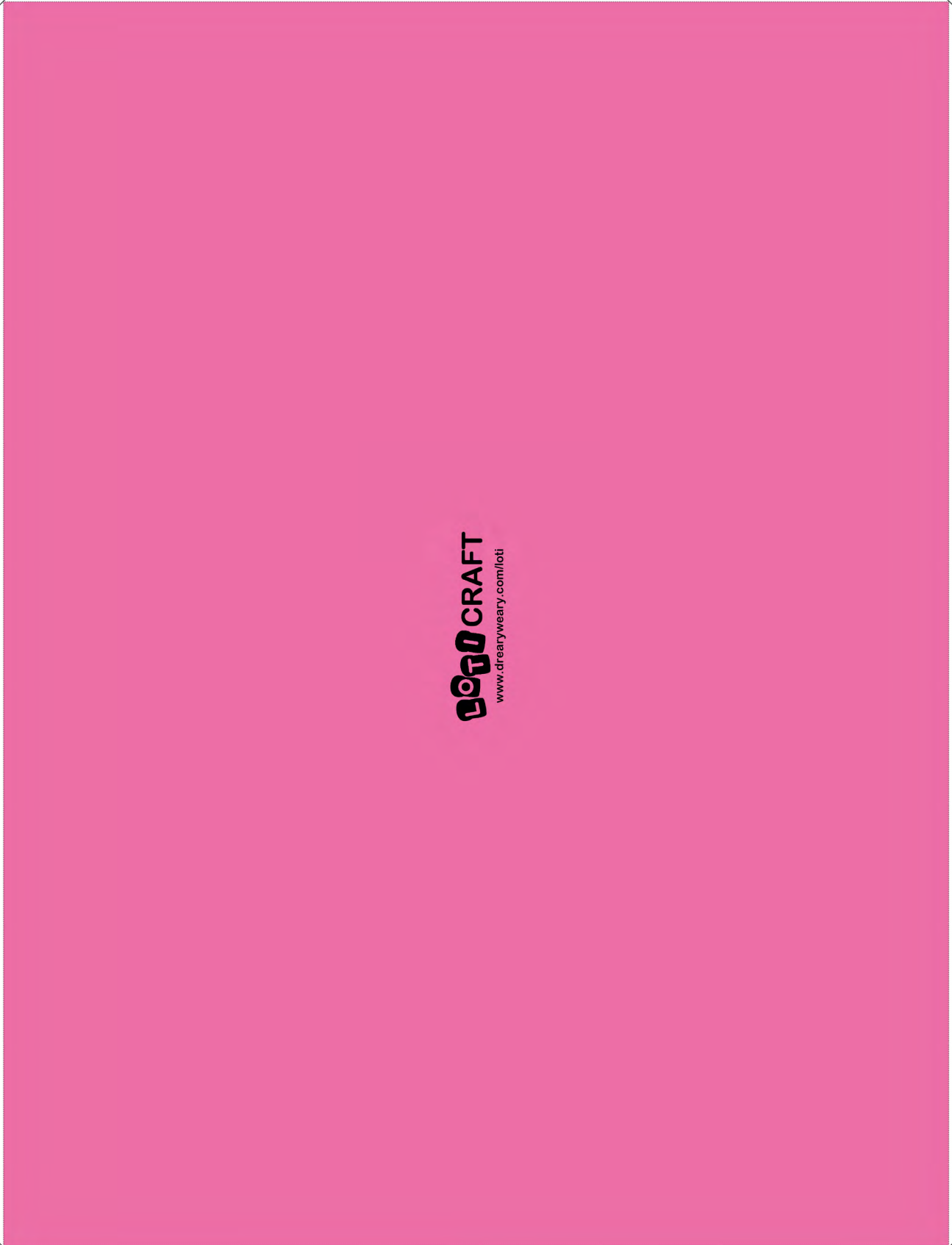

Studs

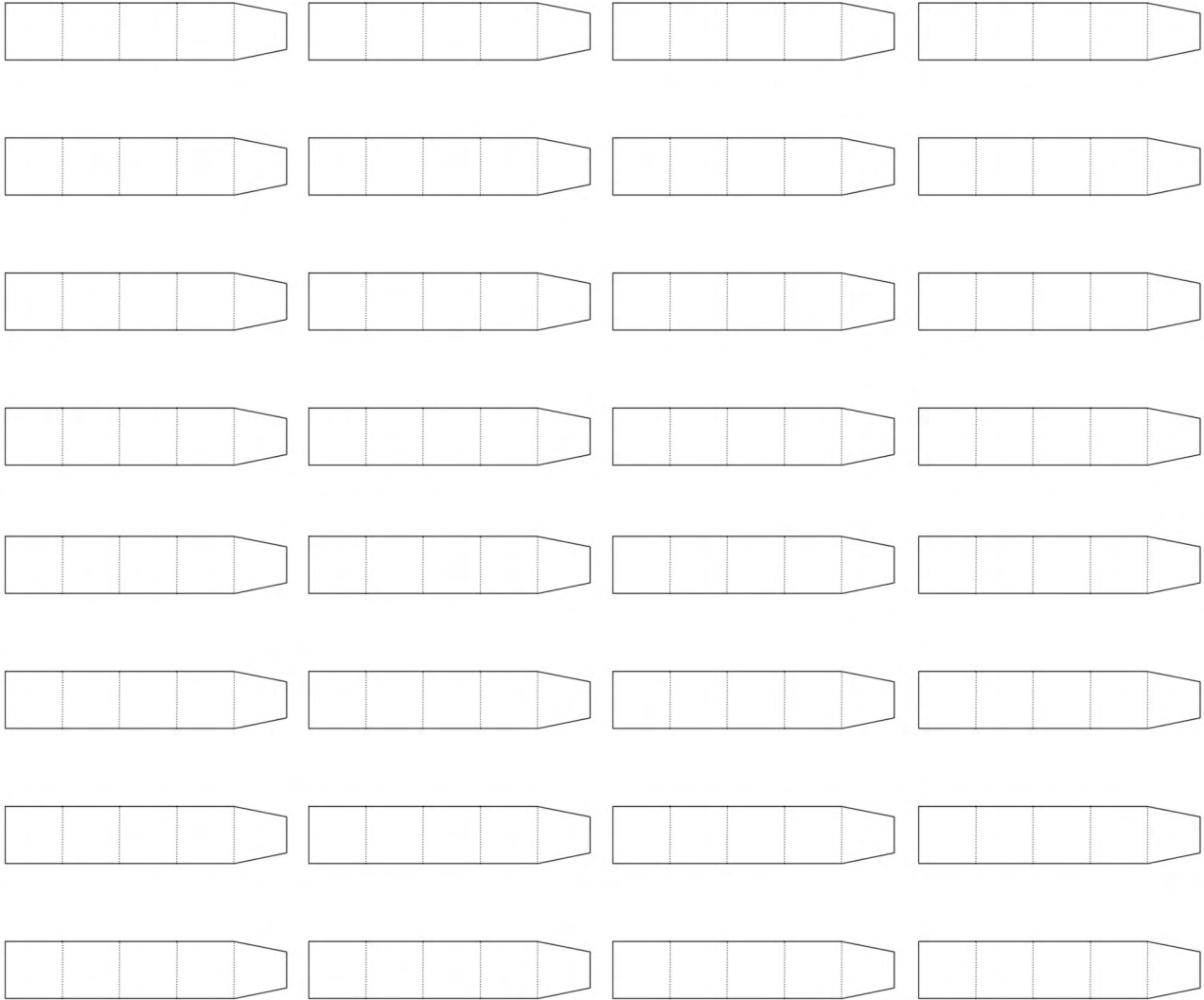

D

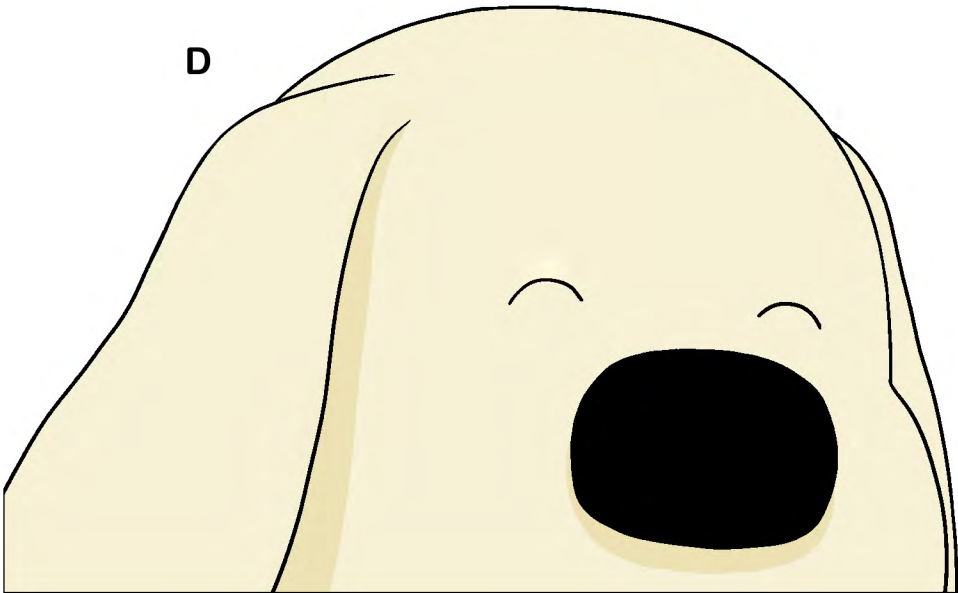

E

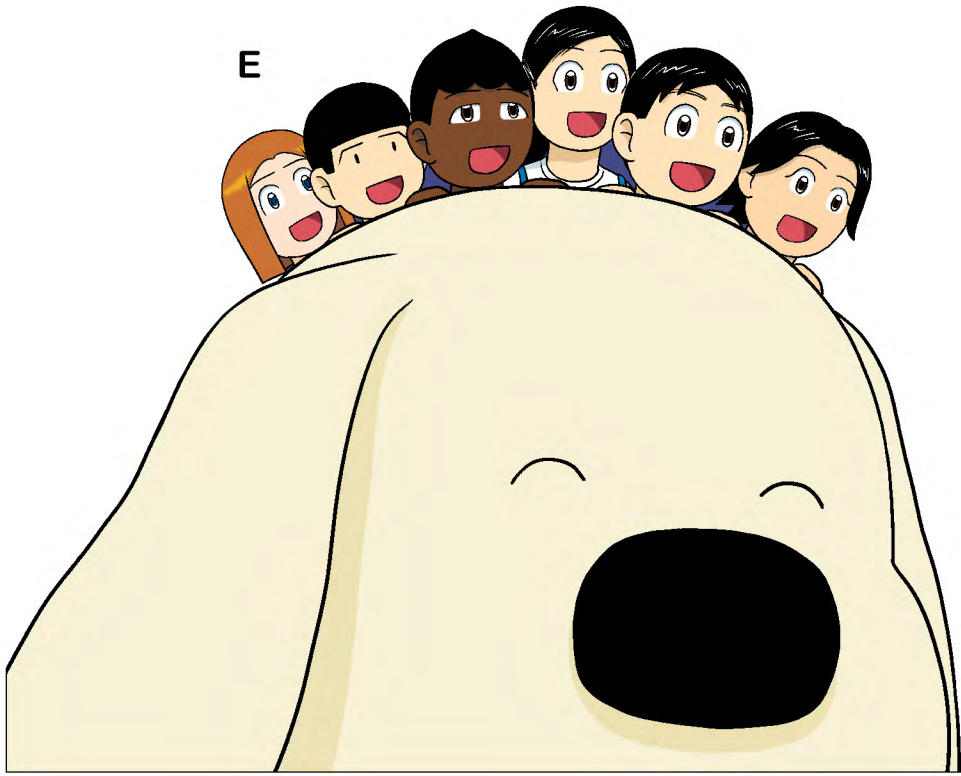

F

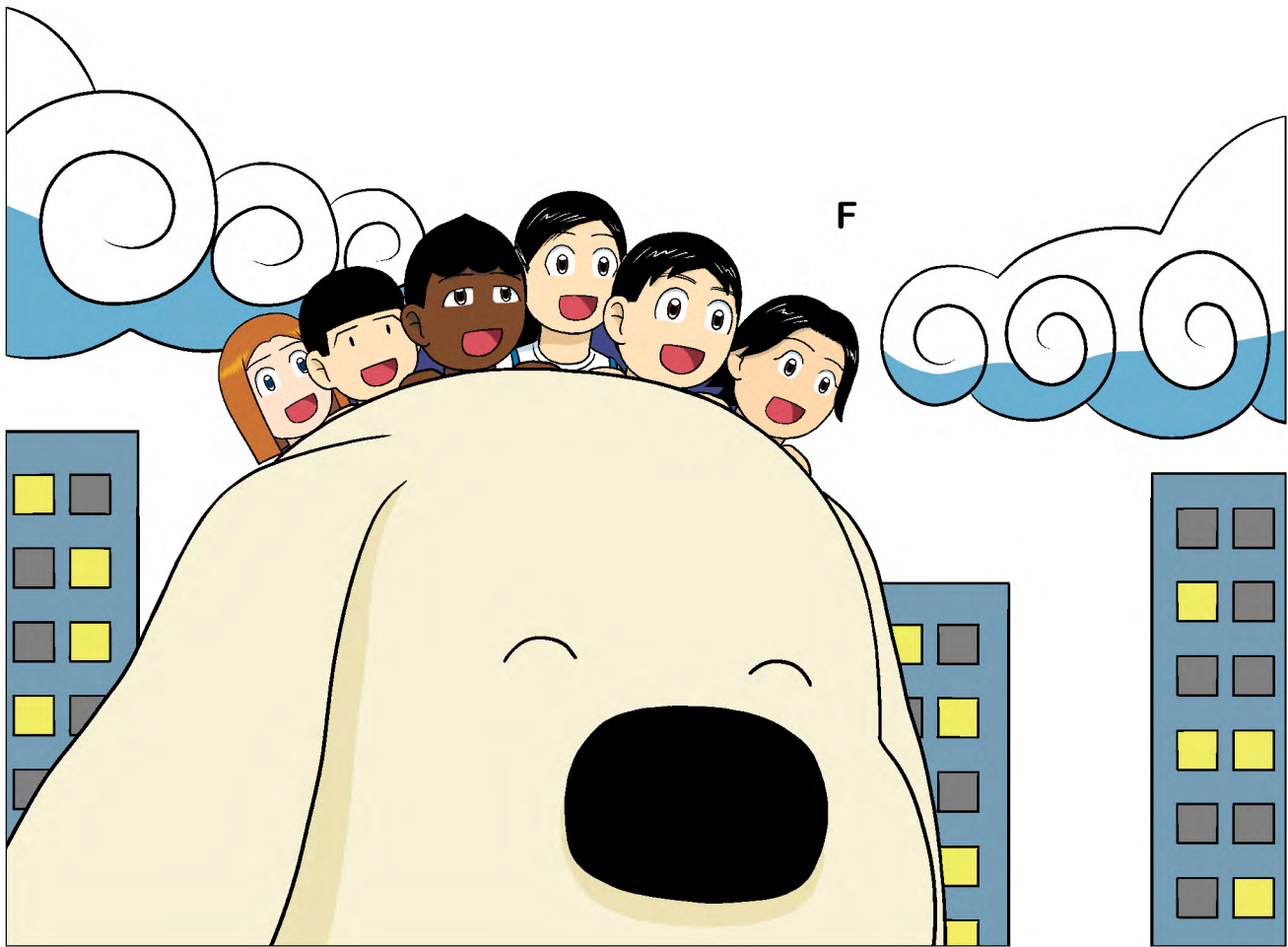

G



H

